

**INTERNATIONAL
PRACTICAL SHOOTING
CONFEDERATION**

HANDGUN TARGET ARRAY BOOK

SEPTEMBER, 2023 EDITION

International Range Officer Association (IROA)
64 Nicholson Crescent, Minesing Ontario
Canada L9X 0G9

Tel: +1 705 733 6989 WhatsApp +1 705 7336989

Email: iroa@ipsc.org Web: www.ipsc.org/iroa

Copyright © 2023 International Range Officer Association (IROA)

SECTION 1: Individual IPSC Targets

- 1.1** When **cutting** scoring IPSC targets or IPSCno-shoots, only the lower portion, or a diagonal portion, or one of the sides can be cut, and a replacement non-scoring border must be fitted (see Rule 4.2.3.2):

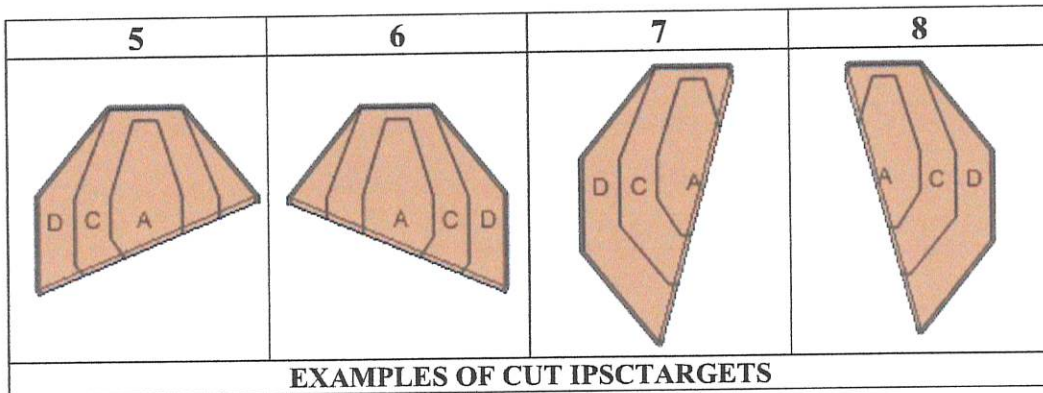
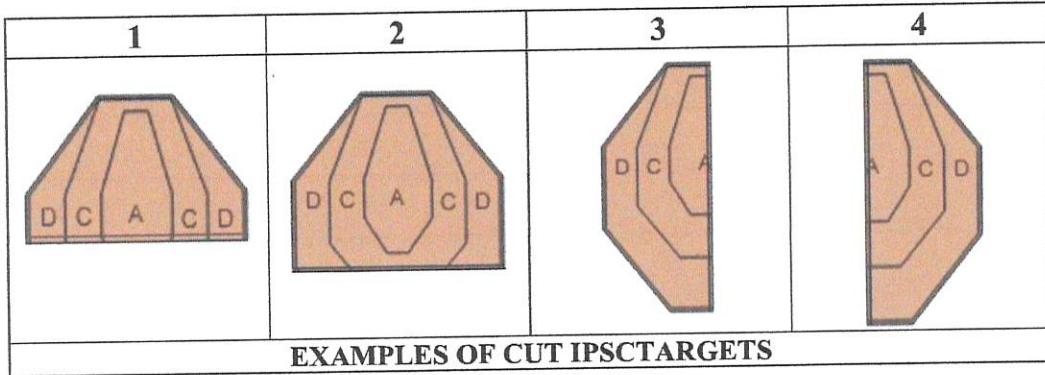

- 1.2** When **painting** scoring IPSC targets or IPSCno-shoots, only the lower portion, or a diagonal portion, or the sides can be painted. A replacement non-scoring border is not necessary, but the use of tape to create a sharply defined boundary of the Hard Cover is recommended (see Rule 4.2.3.3):

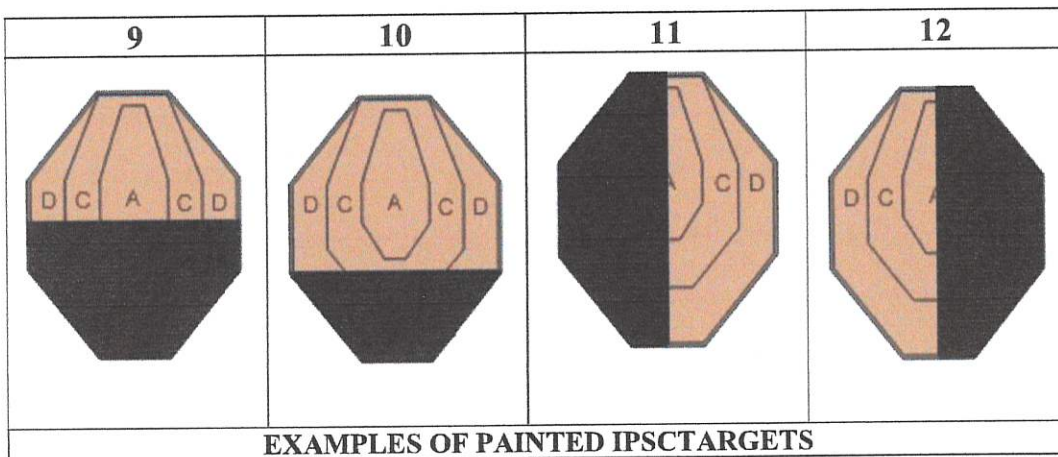

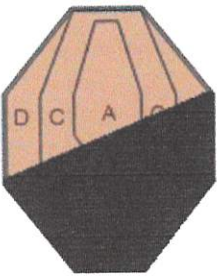
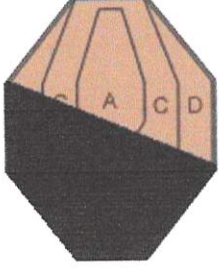
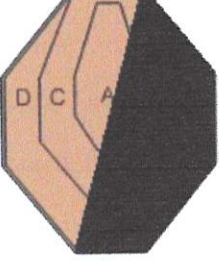
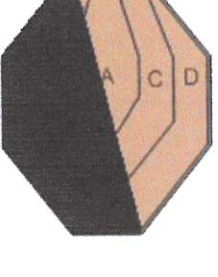
13	14	15	16
			
EXAMPLES OF PAINTED IPSCTARGETS			

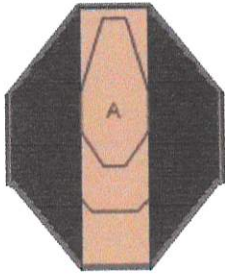
17	18	19	20
	Intentionally Left Blank	Intentionally Left Blank	Intentionally Left Blank

- 1.3 If a single IPSC target is cut vertically to represent two IPSC targets, the two pieces must be placed at least 1m apart. However, a scoring IPSC target may be painted with a vertical strip of Hard Cover, provided it is not treated as more than a single IPSC target (see Rule 4.1.5):

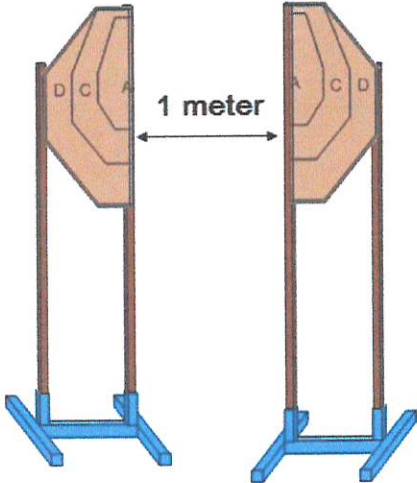
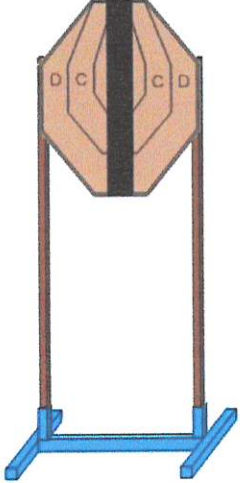
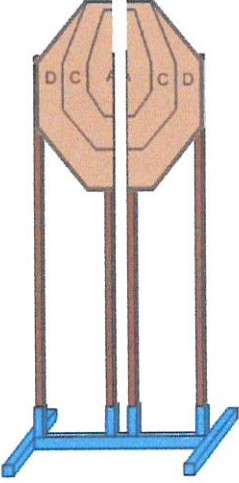
21	22	23
		
ACCEPTABLE	ACCEPTABLE	NOT ACCEPTABLE

- 1.4 A portion of one scoring IPSCtarget or IPSCno-shoot must not be placed within the boundaries of another scoring IPSCtarget or IPSCno-shoot, and a scoring IPSCtarget or IPSCno-shoot must not be hollowed:

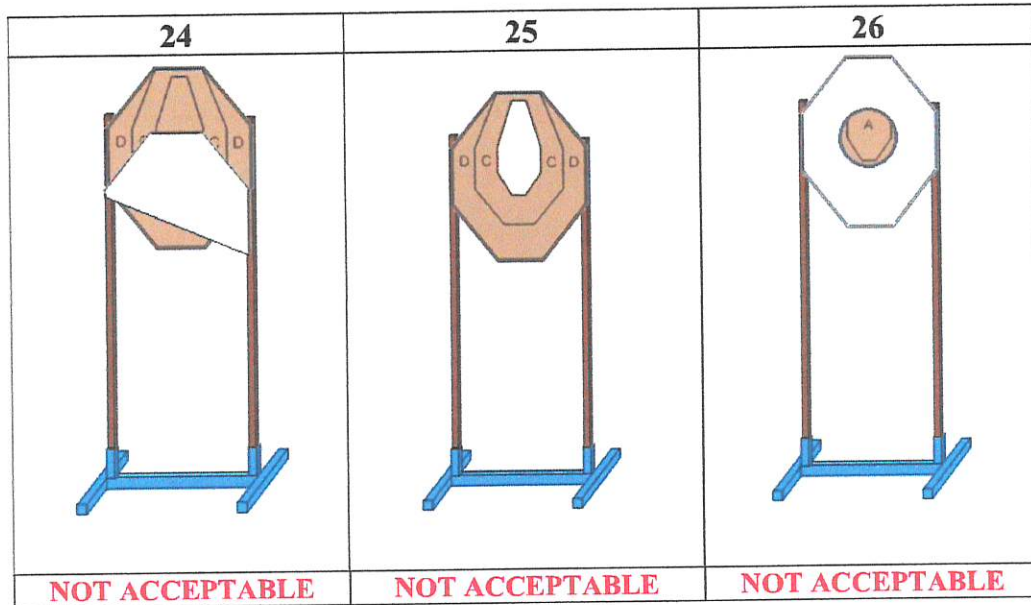

- 1.5 The top of the IPSC Target or IPSCNo-shootsmust never exceed 1.8m in height and IPSC Mini Target orIPSC Mini No-shoots must never exceed 1.6m in height.

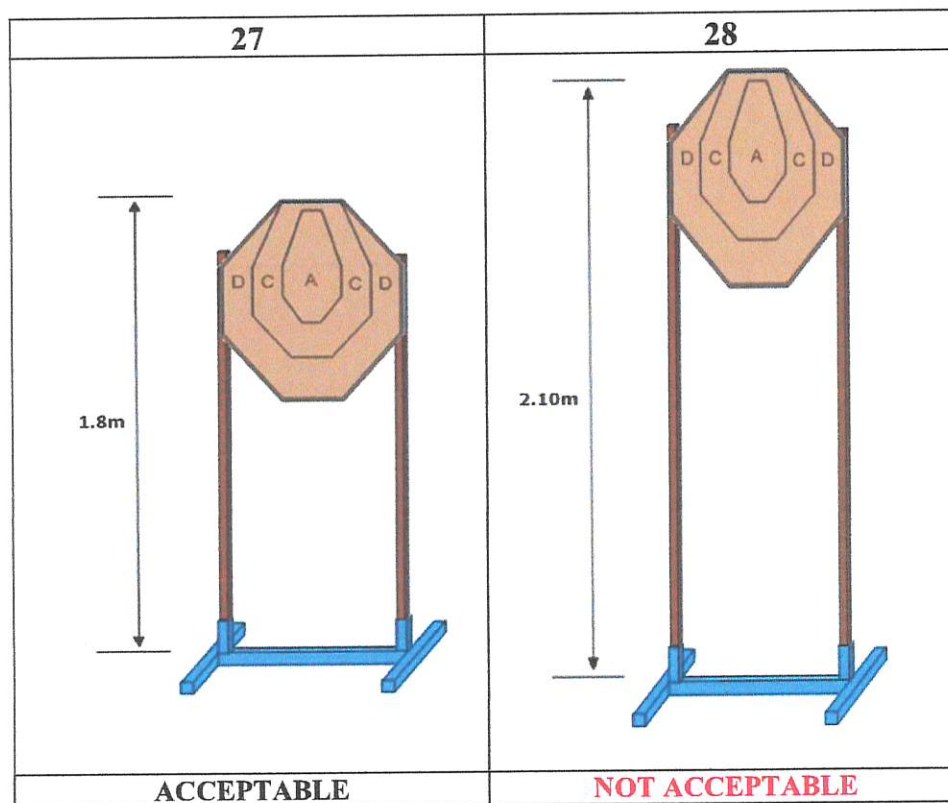

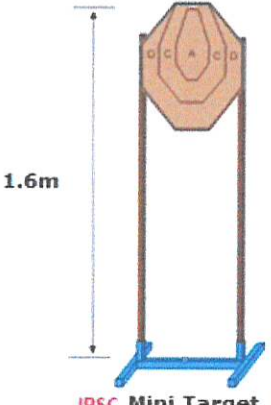
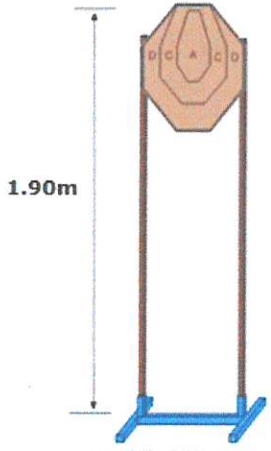
29	30
 <p data-bbox="391 560 454 593">1.6m</p> <p data-bbox="462 772 654 806">IPSC Mini Target</p>	 <p data-bbox="861 515 941 548">1.90m</p> <p data-bbox="933 784 1125 817">IPSC Mini Target</p>
ACCEPTABLE	NOT ACCEPTABLE

1.6 When a lack of contrast with the surrounding area or background necessitates that a different color of IPSC Target be used. (Rule 4.1.2.1). Most applicable at long distances used at mini rifle and rifle matches.

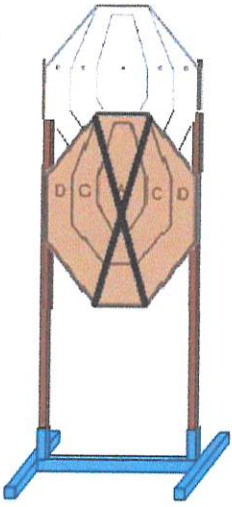
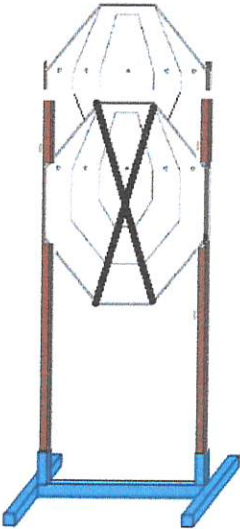
EXAMPLES OF IPSC TARGETS	
31	32
	
ACCEPTABLE	NOT ACCEPTABLE

SECTION 2: Multiple IPSC Targets

2.1 The upper portion of scoring IPSC targets or IPSC no-shoots must never be removed or concealed:

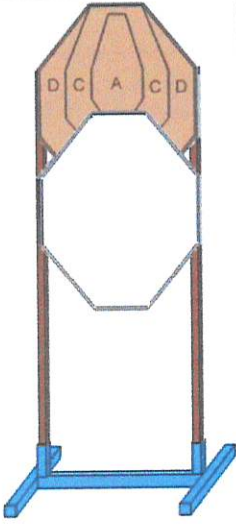
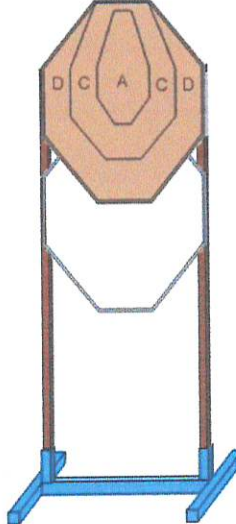
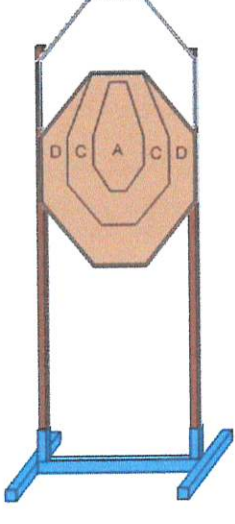
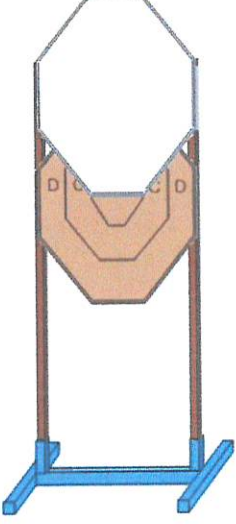
33	34	35	36
			
ACCEPTABLE	NOT ACCEPTABLE	NOT ACCEPTABLE	NOT ACCEPTABLE

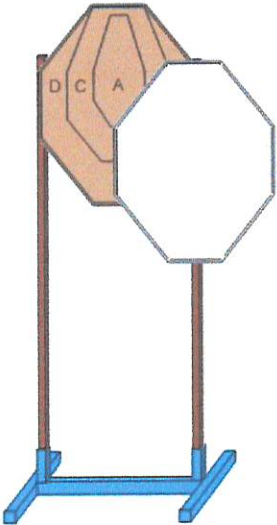
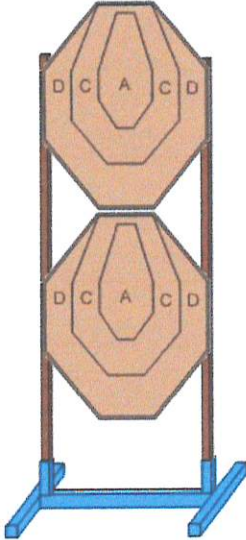
37	38	39
		Intentionally Left Blank
ACCEPTABLE	ACCEPTABLE	

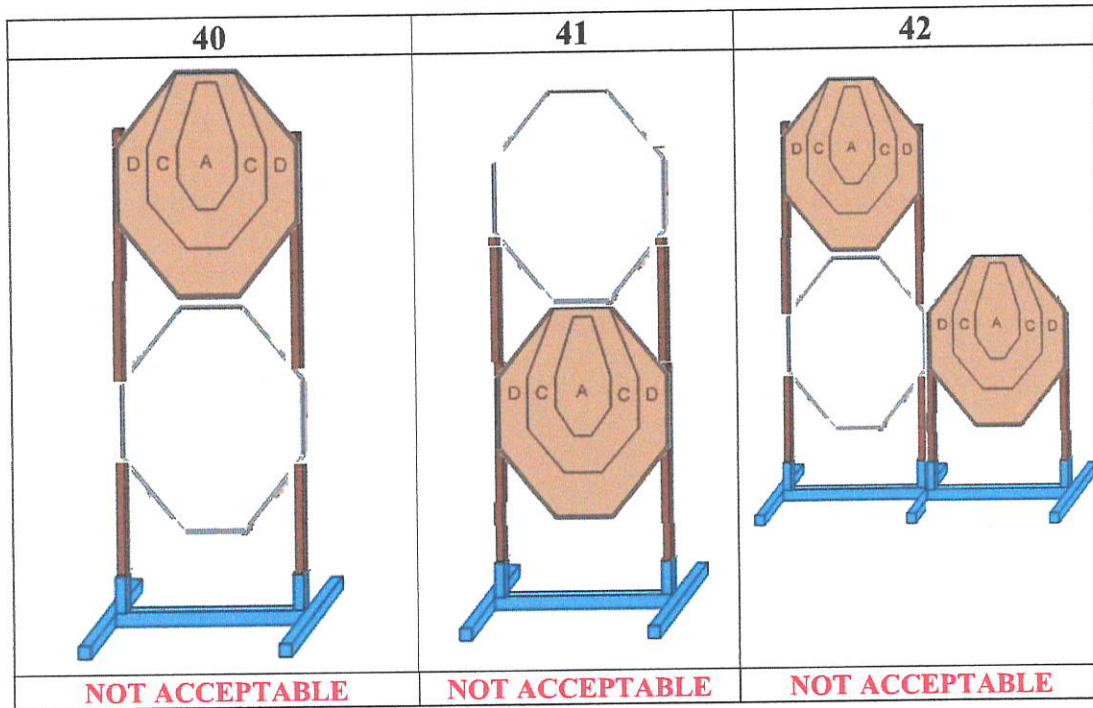

2.2 Whole IPSC targets must not be used as Hard Cover (see Rule 4.1.4.1). To segregate two adjacent scoring IPSC targets, use a IPSC no-shoot:

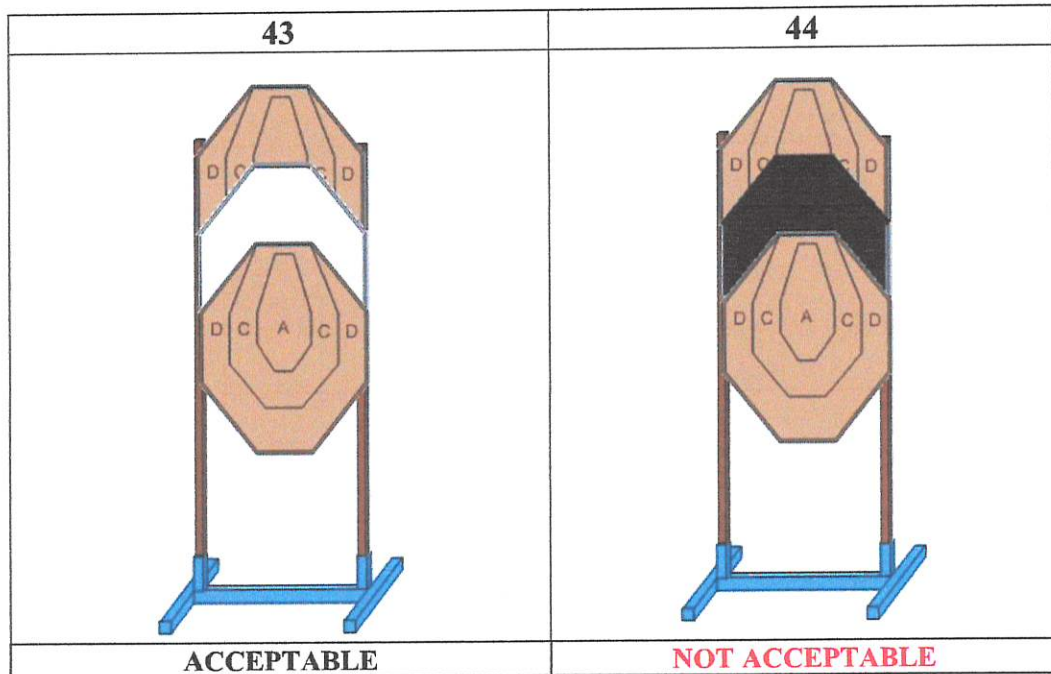

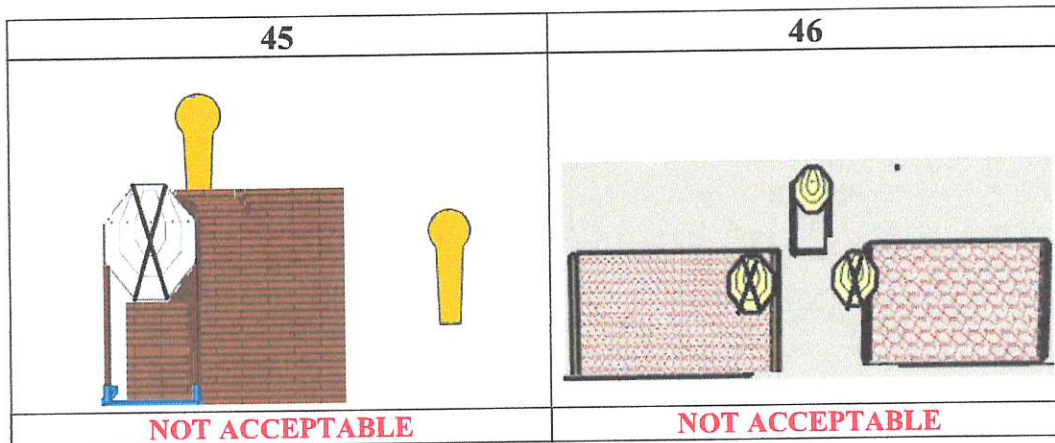

2.3 A IPSCno-shoot may be placed to the forward or to the rear of two adjoining scoring IPSC targets:

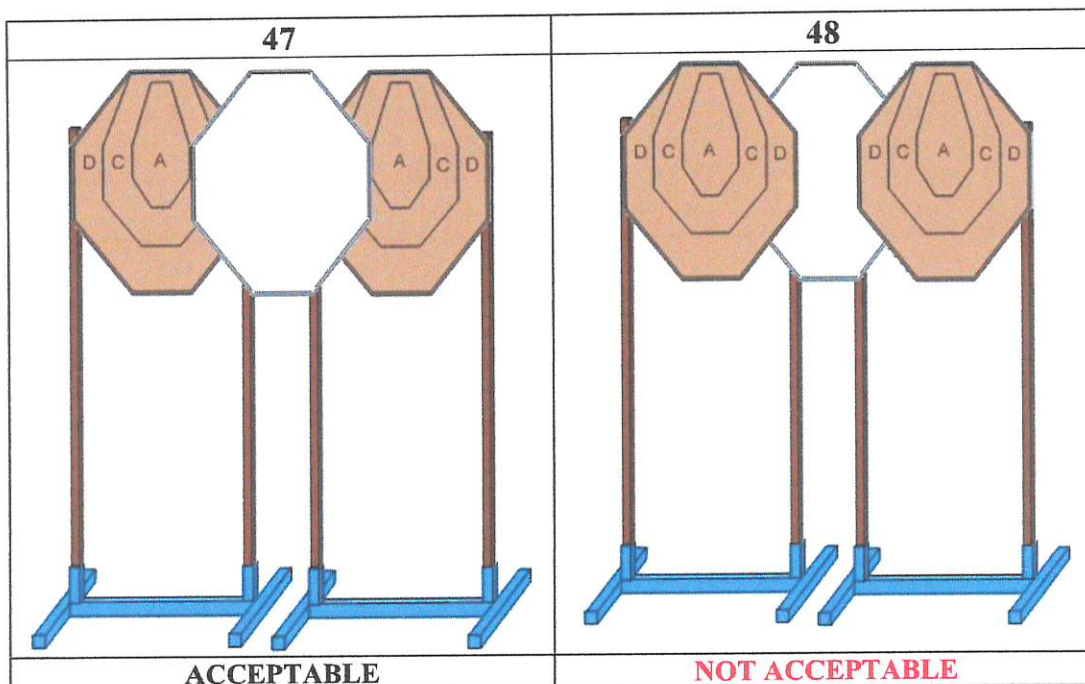

2.4 Overlapping IPSC targets can be comprised of just two scoring IPSC targets, or two scoring IPSC targets with a IPSCno-shoot separating them:

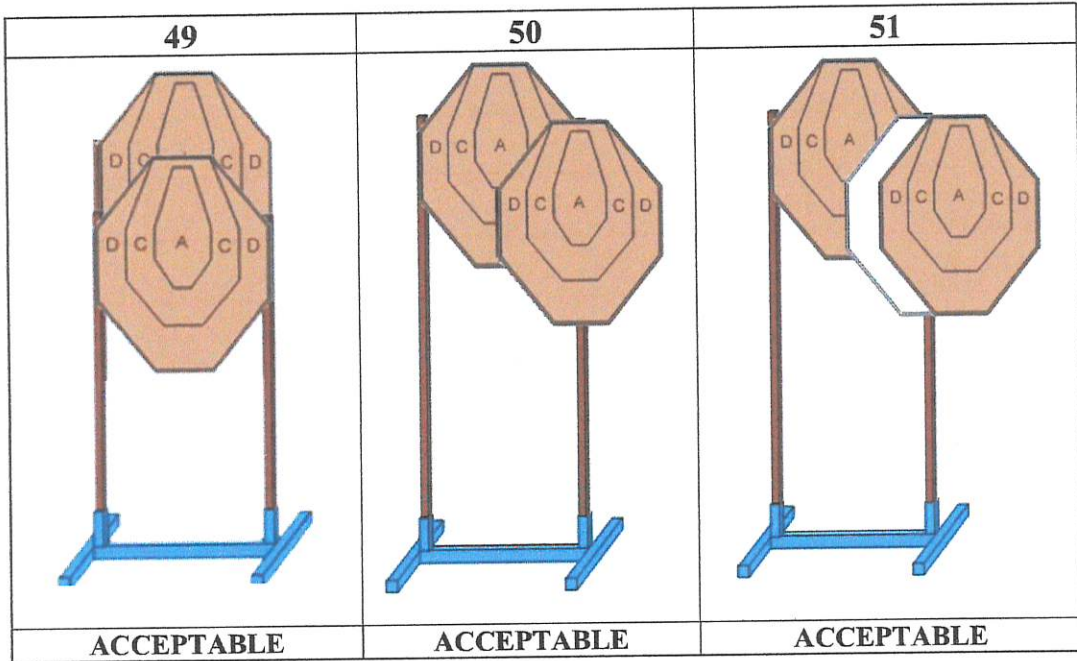

2.5 IPSC Target arrays which are illogical or impractical, or which are overly complicated, thereby making them difficult to replace consistently for the duration of a match, will not be ACCEPTABLE:

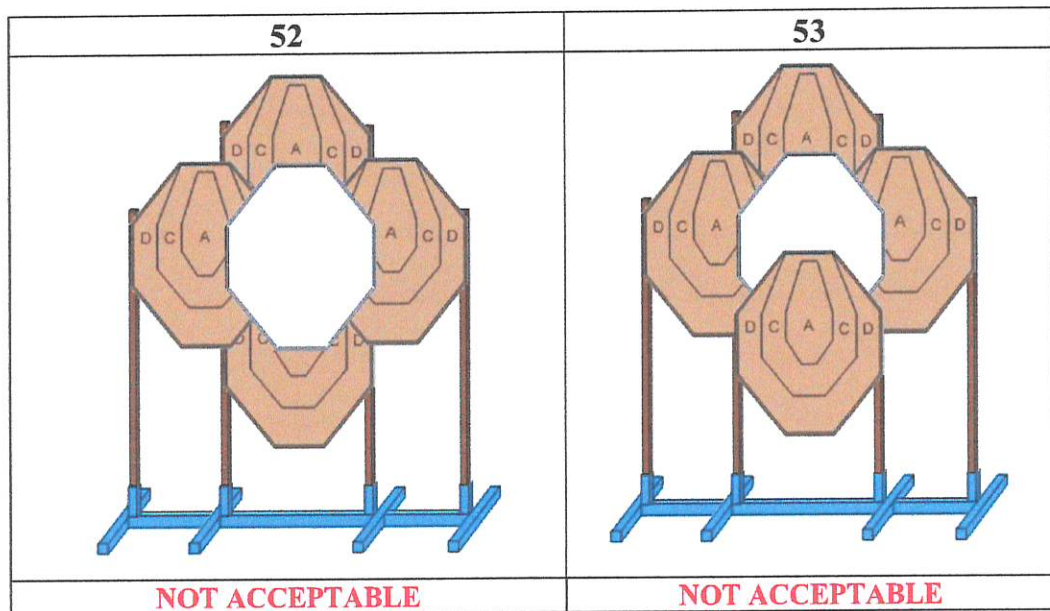

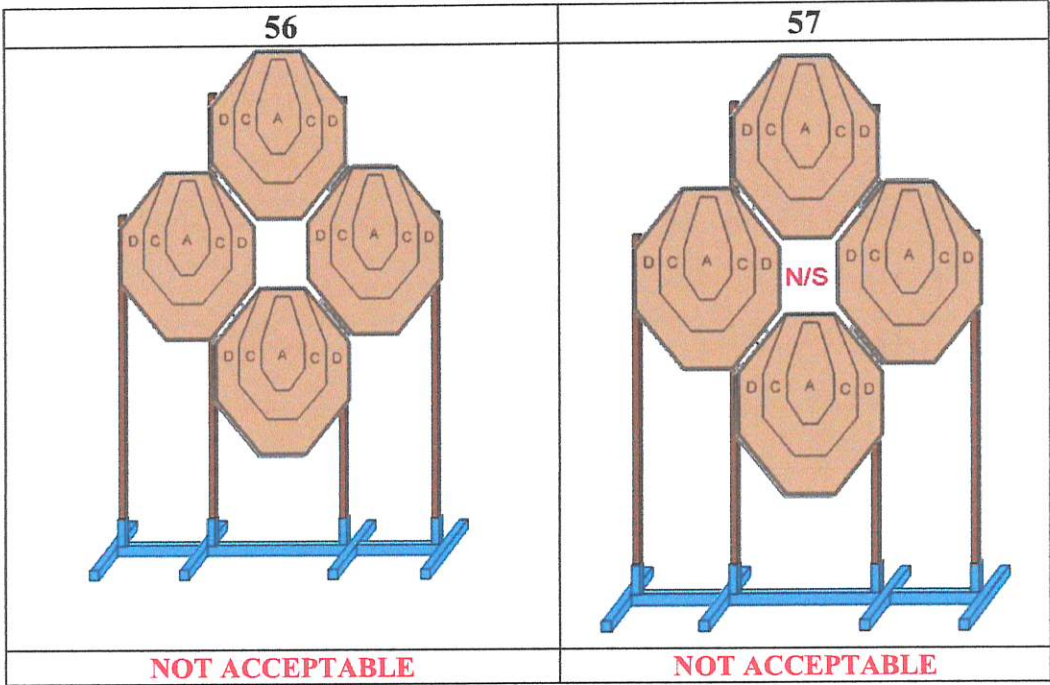
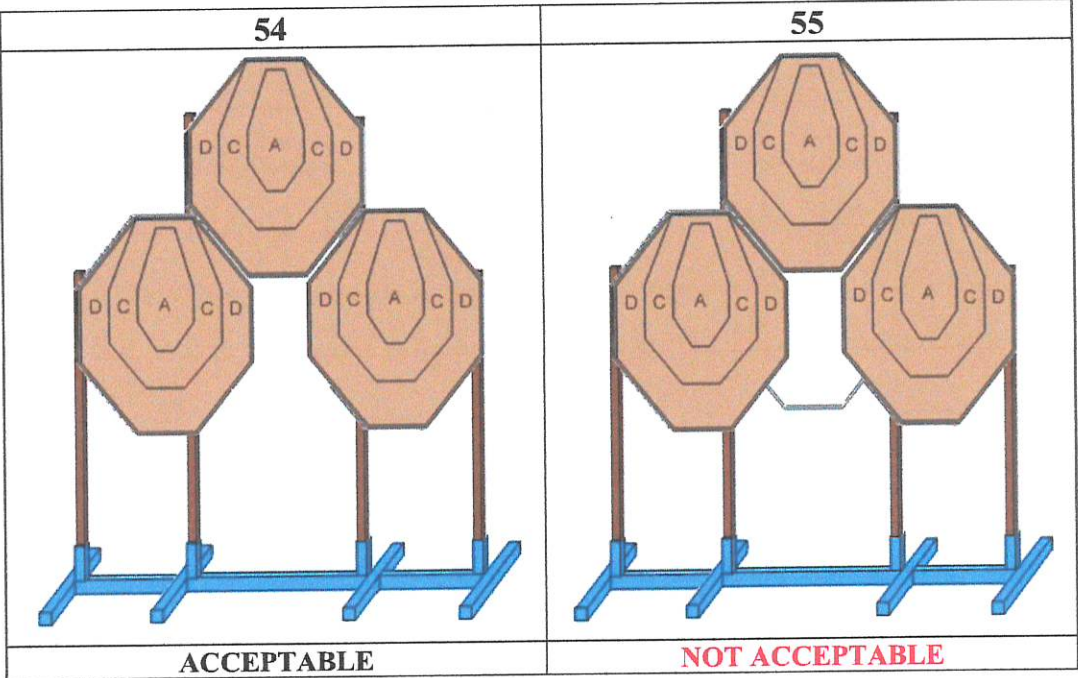

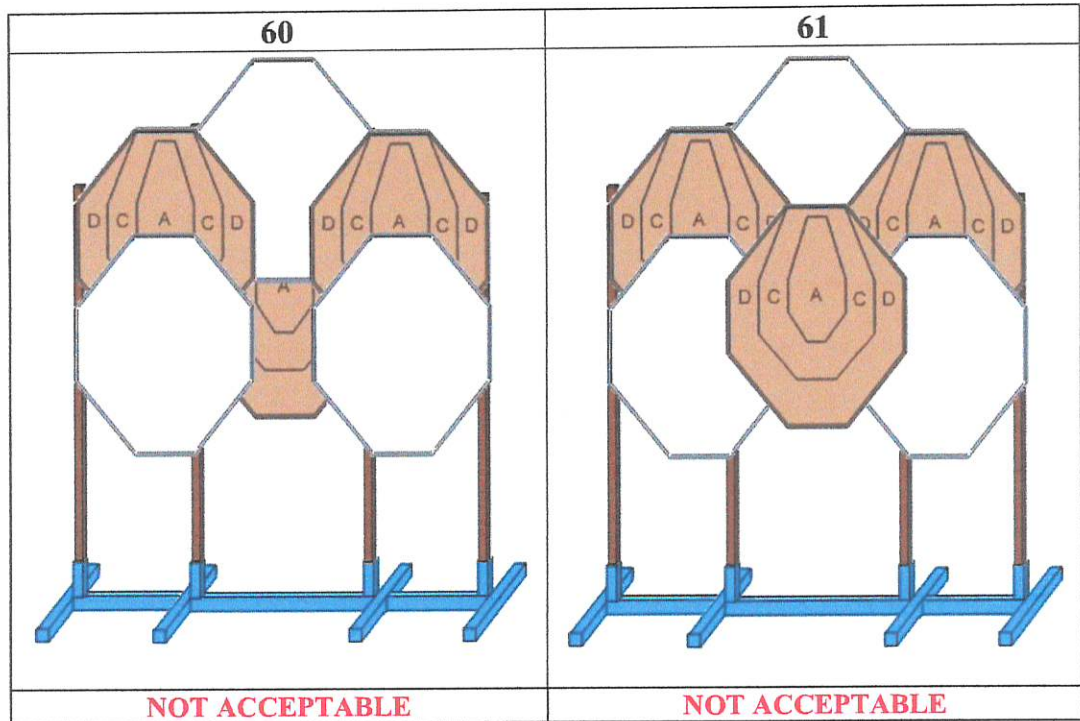
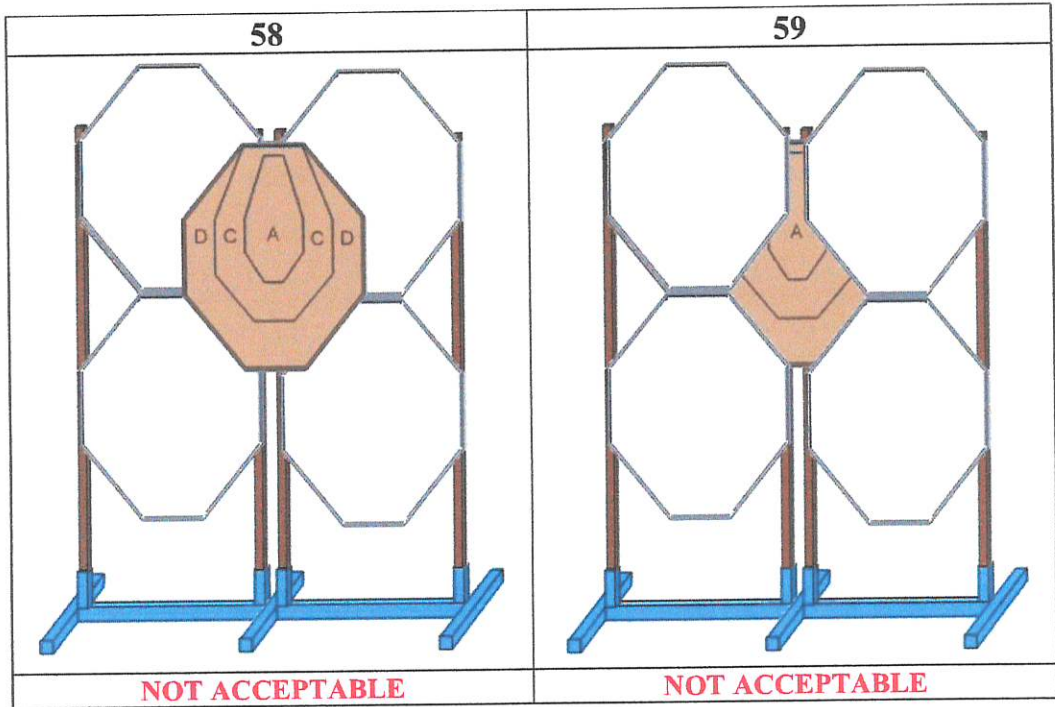

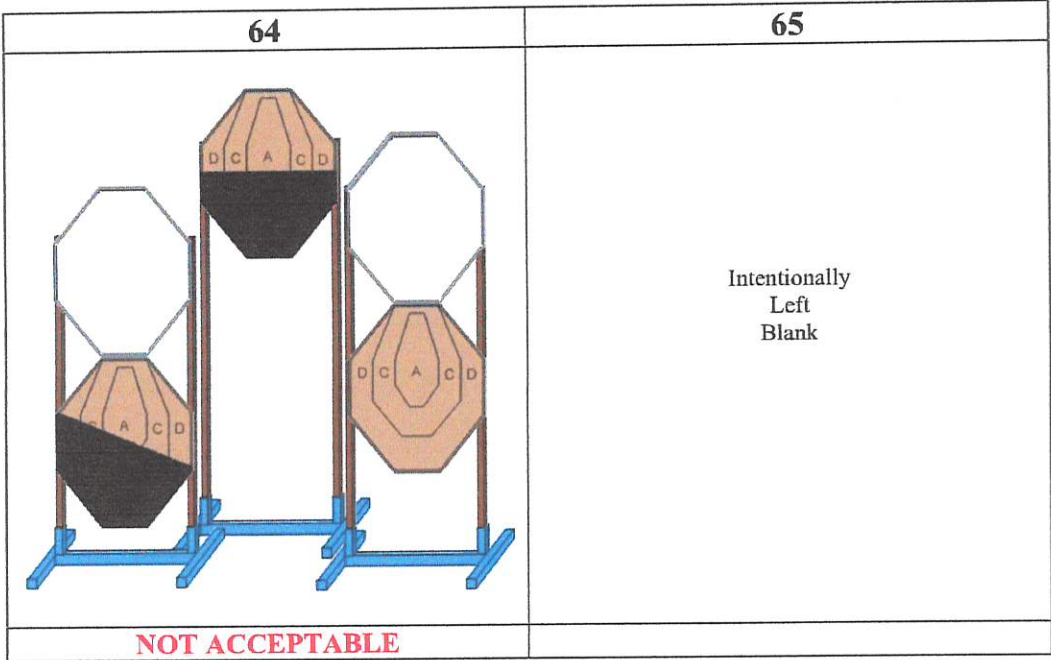
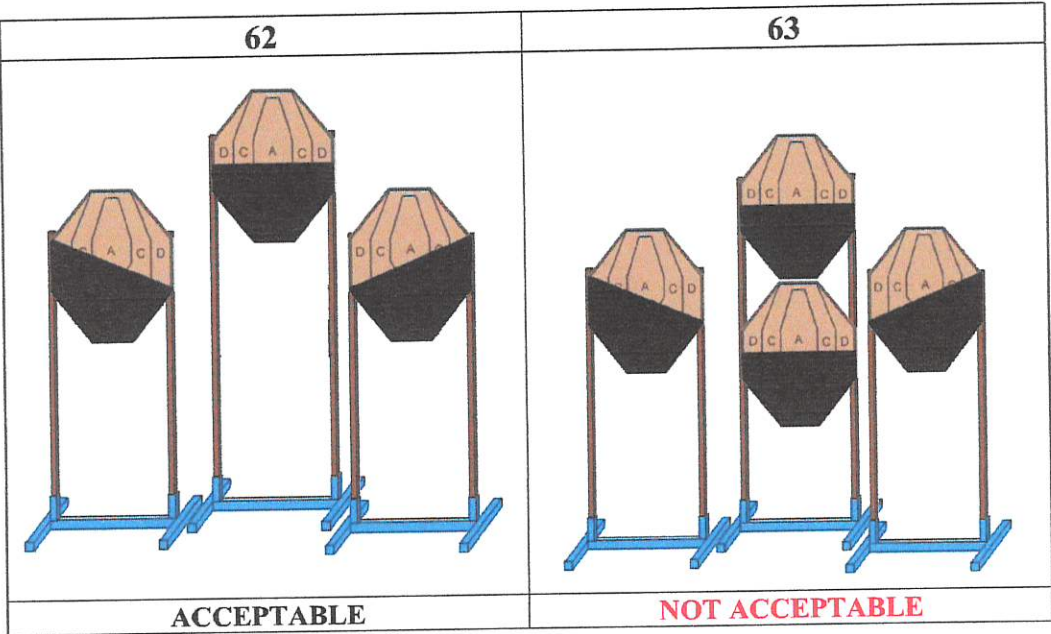

SECTION 3: Mixing IPSC Targets & IPSC Metal Targets

3.1 When mixed together, IPSC Targets and IPSC Metal Targets must offer a practical presentation:

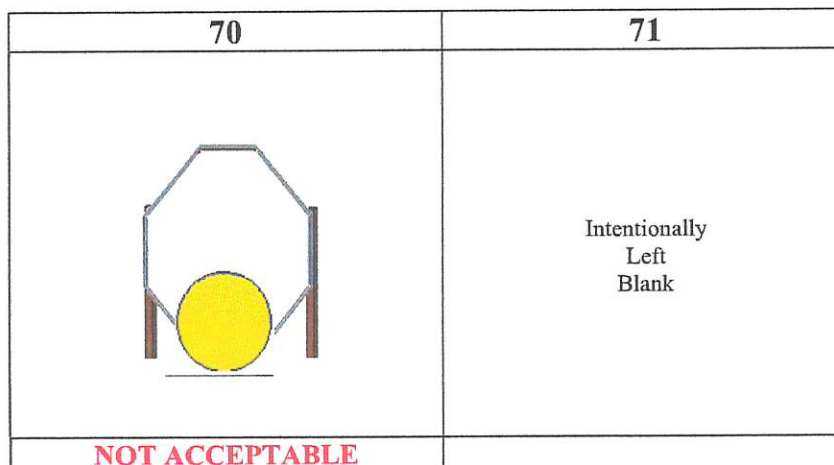
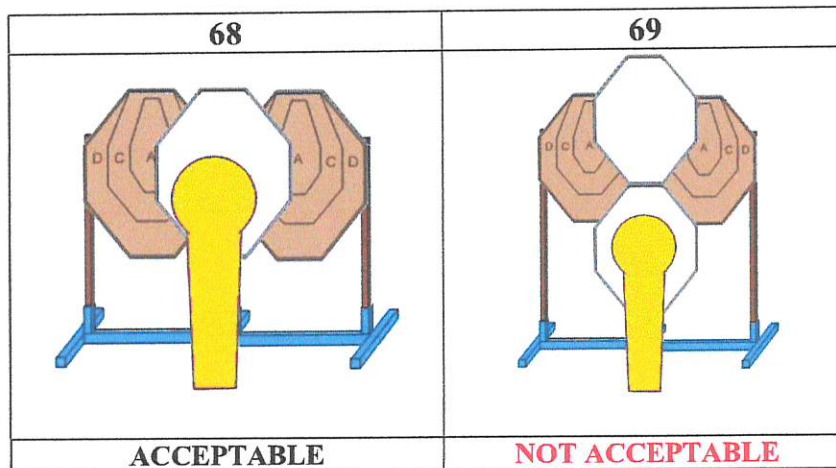
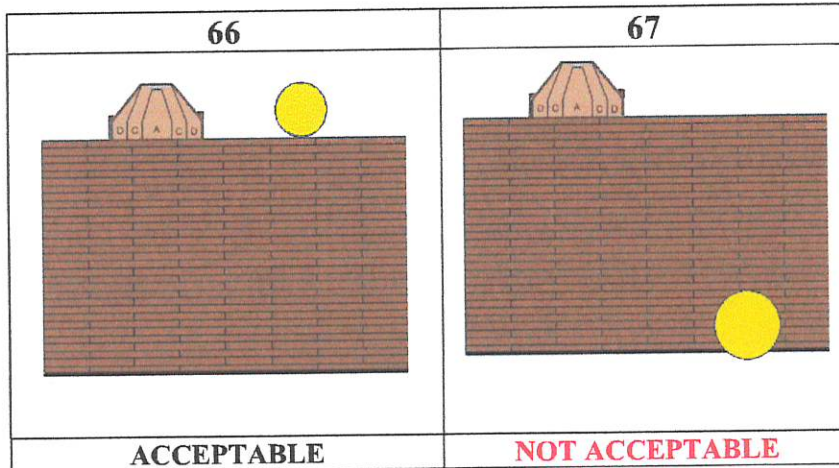

SECTION 4: Carnival Target Arrays

- 4.1 Target arrays such as "stars", "plate racks", "trees", and similar devices are NOT ACCEPTABLE. However, up to 2 authorized IPSC Metalplates, presented above a sturdy common base, may be ACCEPTABLE.

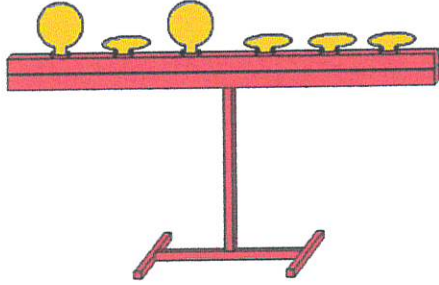
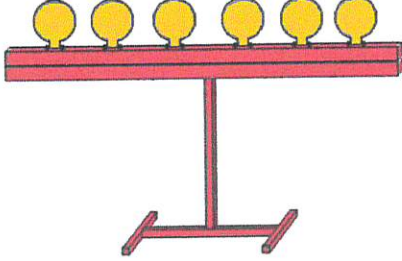
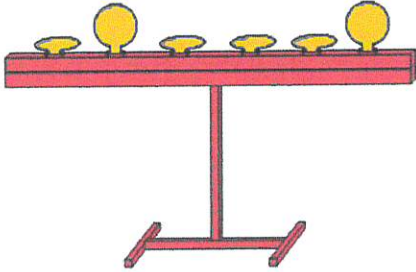
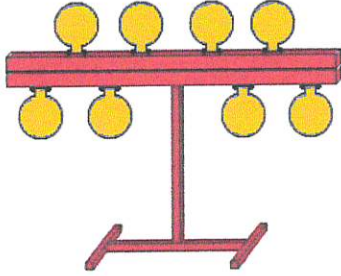
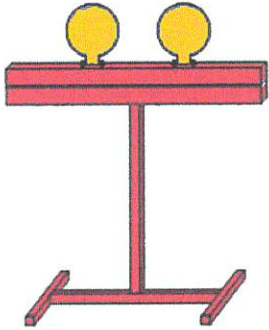
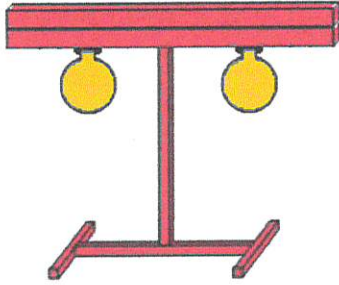
72	73
	
ACCEPTABLE (any combination of 2)	NOT ACCEPTABLE
74	75
	
ACCEPTABLE (any combination of 2)	NOT ACCEPTABLE
76	77
	
ACCEPTABLE	NOT ACCEPTABLE

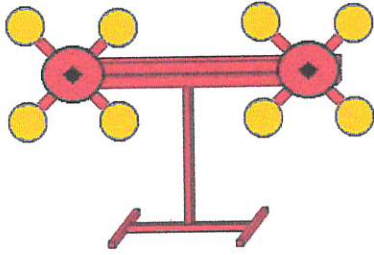
78	79
	<p>Intentionally Left Blank</p>
NOT ACCEPTABLE	

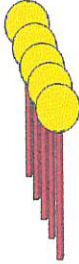
80	81
	
ACCEPTABLE	NOT ACCEPTABLE

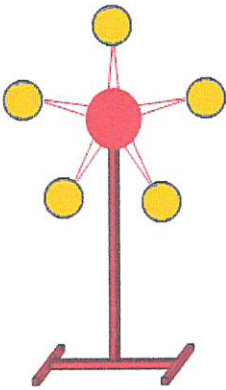
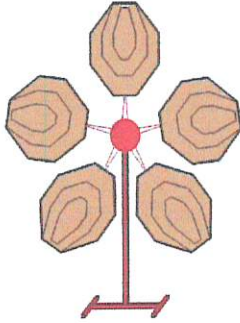
82	83
	
NOT ACCEPTABLE	NOT ACCEPTABLE

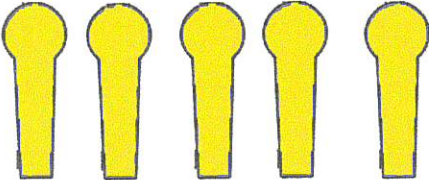
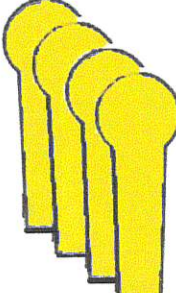
84	85
 <p style="text-align: right;">IPSC Popper</p>	 <p style="text-align: right;">IPSC Popper</p>
ACCEPTABLE	ACCEPTABLE

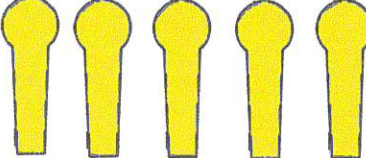
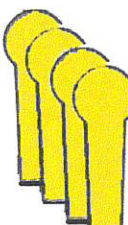
86	87
 <p style="text-align: right;">IPSC MINI POPPER</p>	 <p style="text-align: right;">IPSC MINI POPPER</p>
ACCEPTABLE	ACCEPTABLE

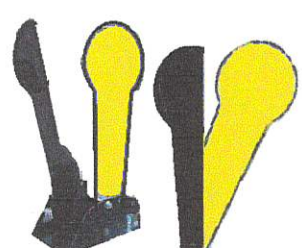
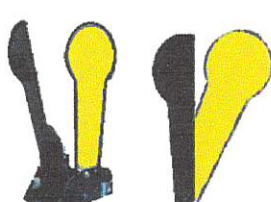
88	89
 <p style="text-align: center;">IPSC Popper</p>	 <p style="text-align: center;">IPSC MINI POPPER</p>
NOT ACCEPTABLE	NOT ACCEPTABLE

SECTION 5: Mixed Target Types and Size Arrays

5.1 The following types and sizes of IPSC Targets must not be included together in the same target array: IPSC Targets and IPSC Mini Targets; or IPSC Poppers and IPSC Mini Poppers (see Rule 4.1.1.2)

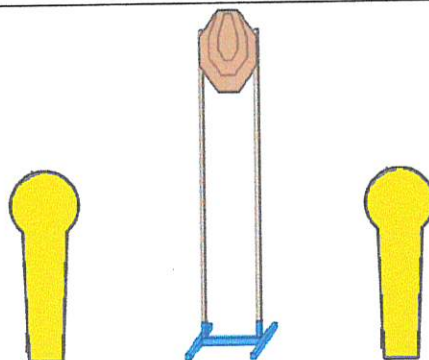
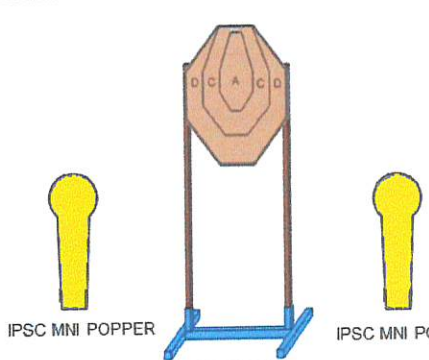
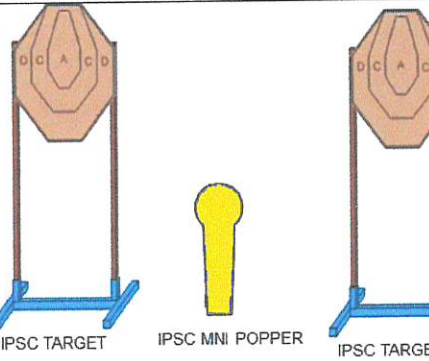
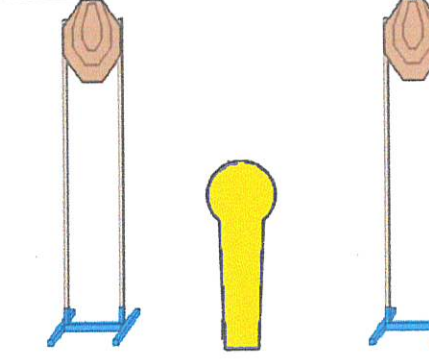
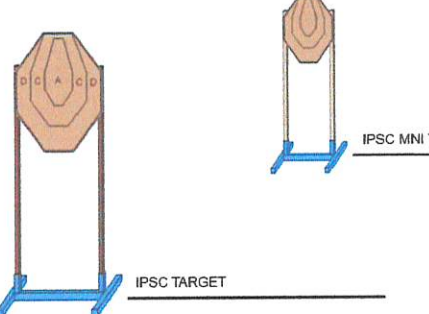
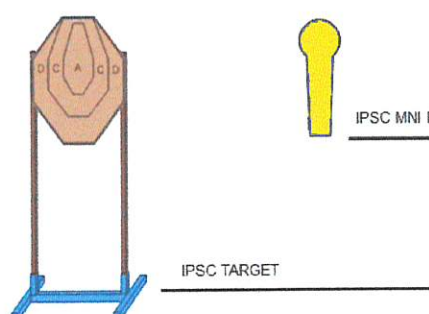
<p>90</p>  <p style="text-align: center;">IPSC POPPER IPSC MINI TARGET IPSC POPPER</p> <p style="text-align: center;">ACCEPTABLE</p>	<p>91</p>  <p style="text-align: center;">IPSC MINI POPPER IPSC TARGET IPSC MINI POPPER</p> <p style="text-align: center;">ACCEPTABLE</p>
<p>92</p>  <p style="text-align: center;">IPSC TARGET IPSC MINI POPPER IPSC TARGET</p> <p style="text-align: center;">ACCEPTABLE</p>	<p>93</p>  <p style="text-align: center;">IPSC MINI TARGET IPSC POPPER IPSC MINI TARGET</p> <p style="text-align: center;">ACCEPTABLE</p>
<p>94</p>  <p style="text-align: center;">IPSC TARGET IPSC MINI TARGET</p> <p style="text-align: center;">NOT ACCEPTABLE</p>	<p>95</p>  <p style="text-align: center;">IPSC TARGET IPSC MINI POPPER</p> <p style="text-align: center;">ACCEPTABLE</p>

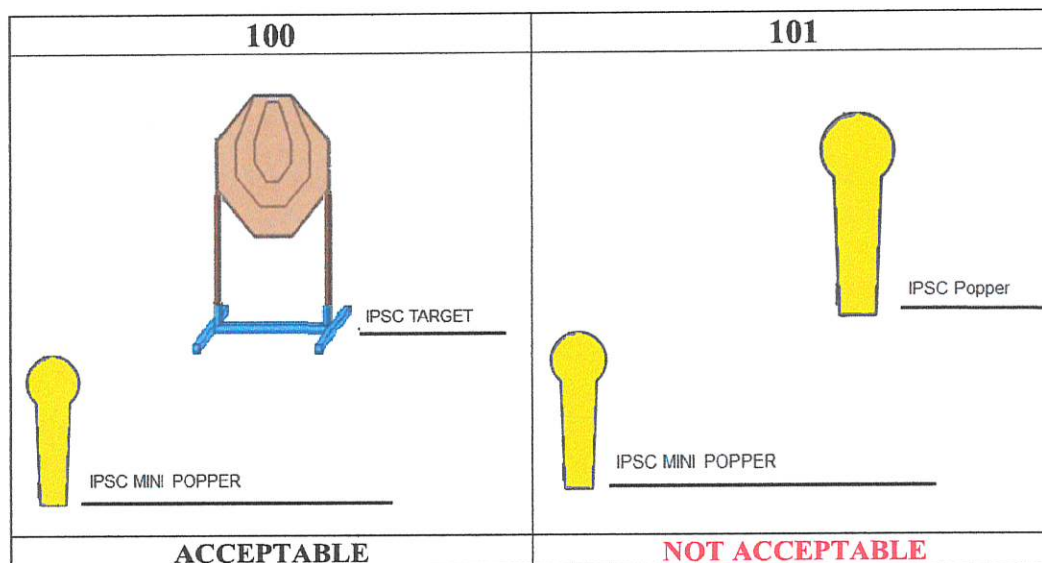
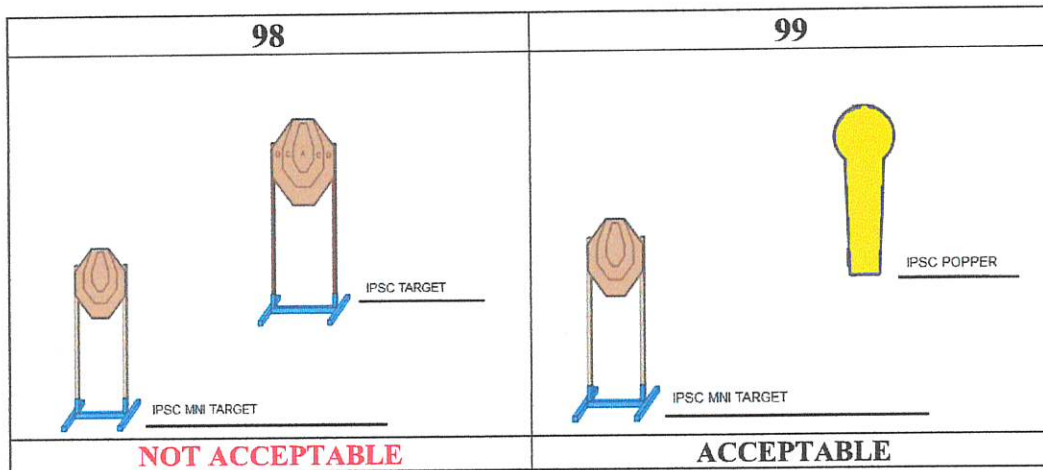
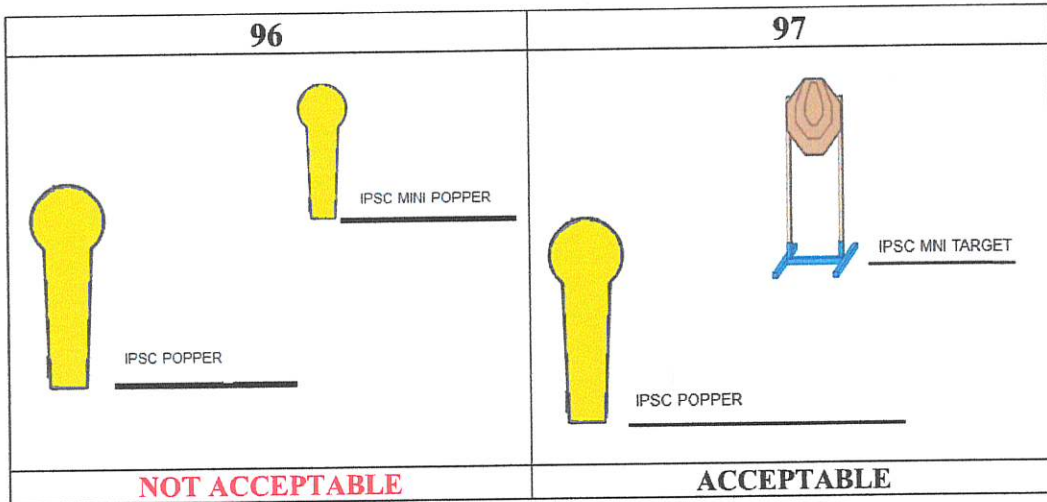

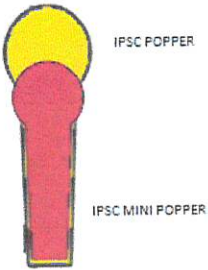
102	103
 <p data-bbox="571 331 654 349">IPSC POPPER</p> <p data-bbox="549 501 667 519">IPSC MINI POPPER</p>	<p data-bbox="1027 367 1155 443">Intentionally Left Blank</p>
<p data-bbox="434 631 702 658">NOT ACCEPTABLE</p>	

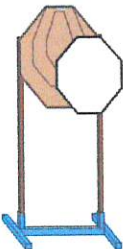
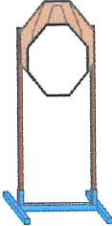
104	105
	
<p data-bbox="434 1099 702 1126">NOT ACCEPTABLE</p> <p data-bbox="960 1099 1228 1126">NOT ACCEPTABLE</p>	

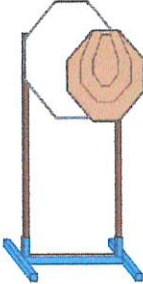
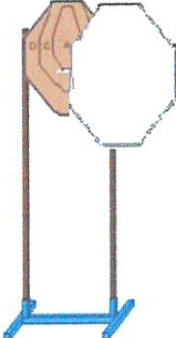
106	107
	
<p data-bbox="434 1644 702 1671">NOT ACCEPTABLE</p> <p data-bbox="960 1644 1228 1671">NOT ACCEPTABLE</p>	

SECTION 6: Stage Design

6.1 The following Cooper tunnel designs must be followed

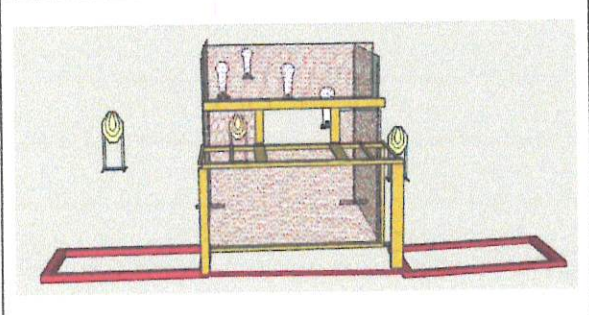
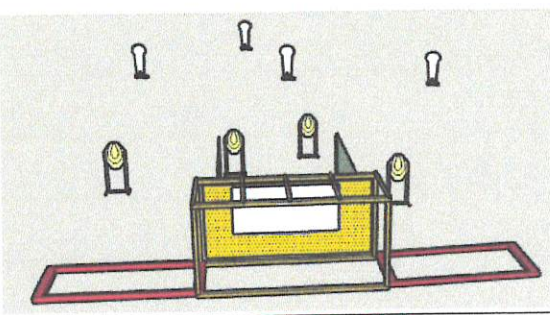
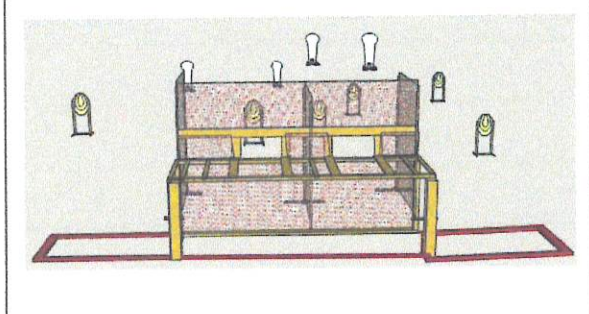
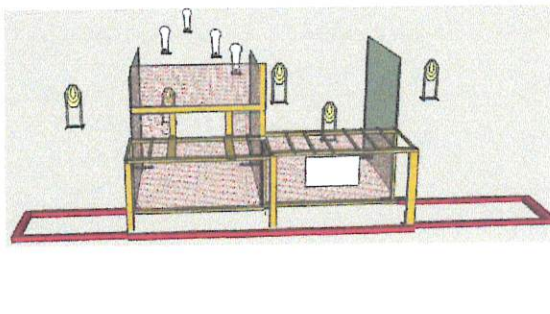
EXAMPLES OF COOPER TUNNELS	
108	109
	
ACCEPTABLE	NOT ACCEPTABLE
110	111
	
ACCEPTABLE	NOT ACCEPTABLE

6.2 The following tunnel designs must be followed

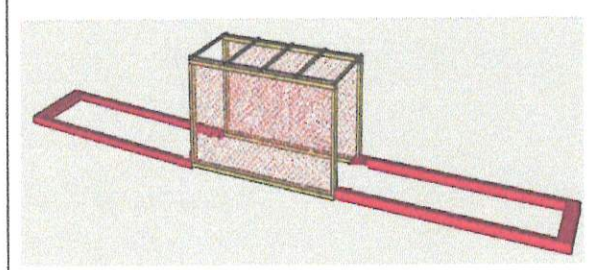
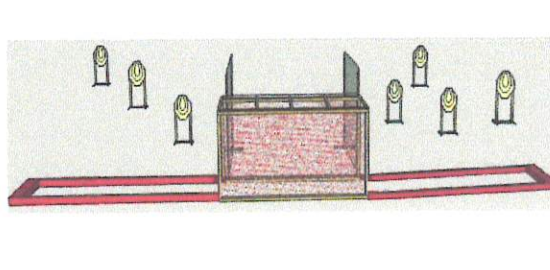
EXAMPLES OF TUNNELS	
112	113
	
ACCEPTABLE	ACCEPTABLE

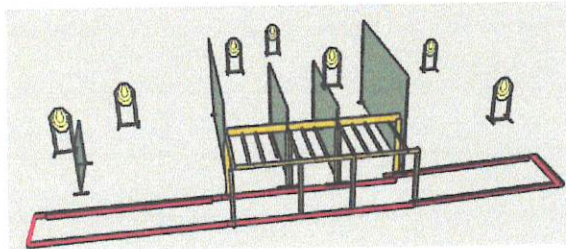
114	115
 <p>The illustration shows a target array setup on a red track. A central yellow and black striped barrier is positioned on the track. Several targets, represented by yellow smiley faces on black stands, are placed around the barrier. A green rectangular board is also visible behind the barrier.</p>	<p>Intentionally Left Blank</p>
<p>NOT ACCEPTABLE</p>	

SECTION 7: Swingers

- 6.3 When using Swinger IPSC Metal Plates, only two (2) IPSC Metal Plates can be used in the swinger at the same time.

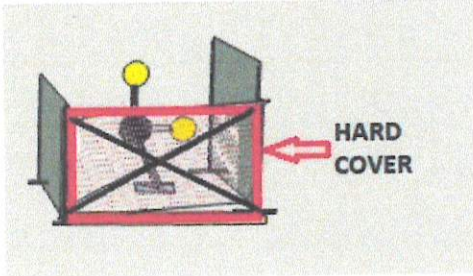
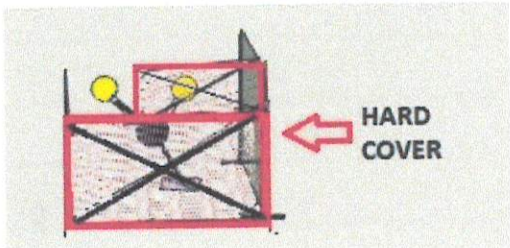
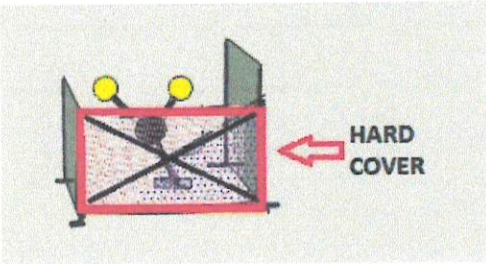
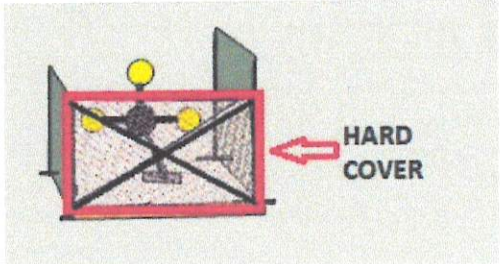
EXAMPLES OF SWINGER IPSC METAL PLATES	
116	117
	
ACCEPTABLE (Only one IPSC Metal Plate must be visible)	ACCEPTABLE (Only one IPSC Metal Plate must be visible)
118	119
	
NOT ACCEPTABLE	NOT ACCEPTABLE

6.4 When using Swingers, IPSC metal No shoots or IPSC paper No shoots must remain still.

EXAMPLES OF SWINGER IPSC TARGETS	
120	121
ACCEPTABLE	NOT ACCEPTABLE
122	123
ACCEPTABLE	NOT ACCEPTABLE

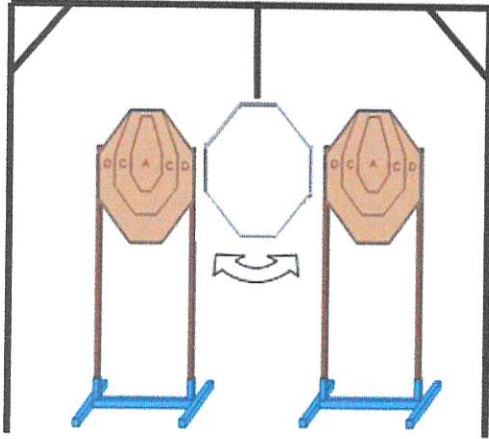
124	125
	<p data-bbox="1011 479 1134 562">Intentionally Left Blank</p>
<p data-bbox="344 842 612 875">NOT ACCEPTABLE</p>	

SECTION 8: Shooting Area

6.5 When a competitor ready condition requires that the firearm or magazines, or speed loaders be placed on a table or similar, the table or similar must be inside the clearly demarcated shooting area.

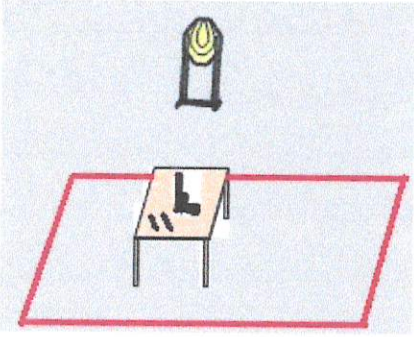
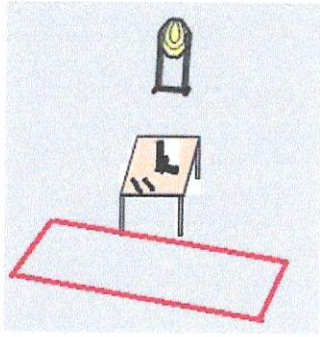
126	127
	
ACCEPTABLE	NOT ACCEPTABLE

6.6 When using a mechanical activator (e.g. a rope, a lever, pedal, flap, door, etc), the mechanical activator must be inside the clearly demarcated shooting area.

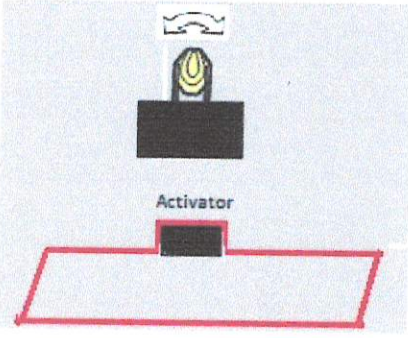
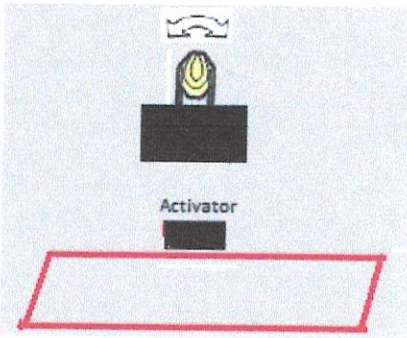
128	129
	
ACCEPTABLE	NOT ACCEPTABLE